

BE POWER[®] EQUIPMENT

DIESEL GENERATOR USER MANUAL

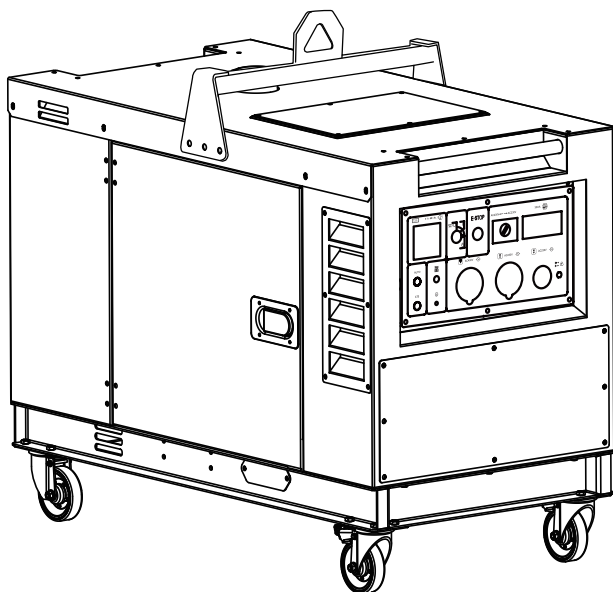

G10000DS-ILE















CONTENTS

SAFETY	3
CONTROL PANEL ELEMENTS	4
FILTER POSITION	5
BEFORE START	
- OIL FILLING	6
- CONNECTING THE BATTERY CABLE	7
- FILLING THE FUEL TANK	8
- REMOVE AIR FROM FUEL PIPE	9
OPERATION	
- START	10
- AUTO START	11
- STOP	12
MAINTENANCE	
- OIL CHANGE	13
- OIL FILTER CLEAN	14
- AIR FLITER	15
- FUEL FILTER	16
TECHNICAL DATA	17
TROUBLESHOOTING	18

DISCLAIMER: The information, specifications, procedures, and diagrams provided for this machine are subject to change at any time without prior notice. Updates may occur due to product improvements, regulatory requirements, or technical revisions. Always refer to the most current documentation and verify details with the manufacturer or authorized service provider before use.

DIESEL GENERATOR USER MANUAL

SAFETY

 <p>Perform a visual inspection of the external and internal components.</p>	 <p>Always store the generator in an area with good ventilation.</p>
 <p>The generator is designed for operation within a temperature range of +5°C to +40°C.</p>	 <p>For long-term storage, keep the equipment in a dry location. Frost can cause damage. Ensure the equipment is thoroughly dried before storing it in a dry, room temp area.</p>
 <p>REGULARLY clean the air filter. All filters must be cleaned regularly. All components must be cleaned regularly</p>	 <p>Never place the generator in an inclined or vertical position, to avoid fuel loss and equipment damage</p>
 <p>The exhaust gases contain carbon monoxide This gas is colorless and highly dangerous. NEVER OPERATE THIS EQUIPMENT INDOORS OR IN POORLY VENTILATED AREAS.</p>	 <p>The exhaust becomes very hot during operation and remains warm for some time after the generator is switched off. Avoid touching the exhaust and allow the equipment to cool down completely before moving it.</p>
 <p>Repairs on the generator must be carried out by a qualified or authorized professional.</p>	 <p>Do not smoke or allow open flames or sparks near the generator, especially when refueling. To prevent fire or explosion hazards, do not store the generator near flammable materials.</p>
 <p>Always inspect the equipment for any screws or nuts that may have loosened due to vibration.</p>	 <p>Failure to follow the procedures outlined in this manual may result in equipment damage and will void the warranty.</p>
 <p>ALWAYS use high-quality oil and fuel. Regularly check oil and fuel levels, and ensure that oil and fuel filters are properly maintained.</p>	

CONTROL PANEL ELEMENTS

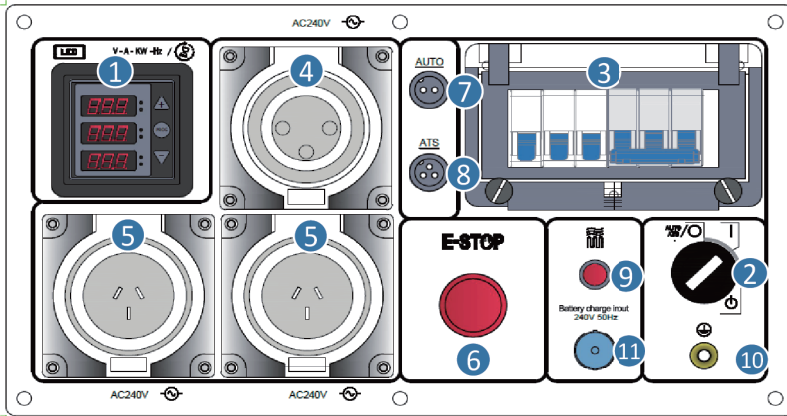

No	Parts Name
1	LED6 Display
2	Start key
3	SAA breaker
4	240V-32A Single phase socket
5	240V-15A Single phase socket
6	E-STOP
7	AUTO Socket
8	ATS socket
9	Air-preheater button
10	Ground terminal
11	Battery charger socket

FILTER POSITION

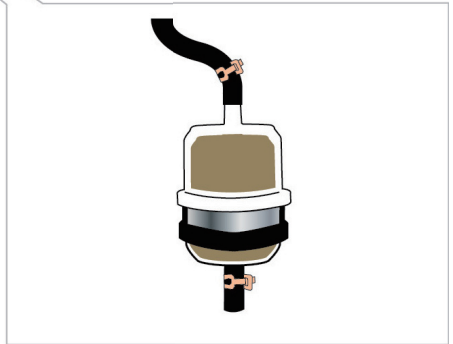
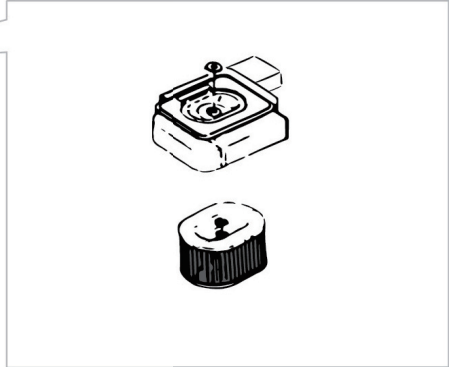

OIL FILLING



15W40
10W30

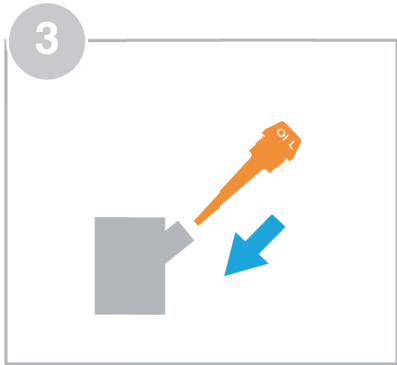
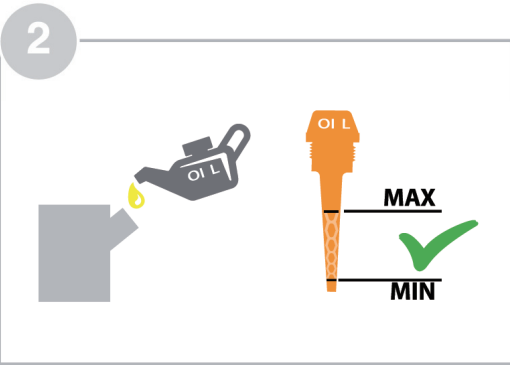
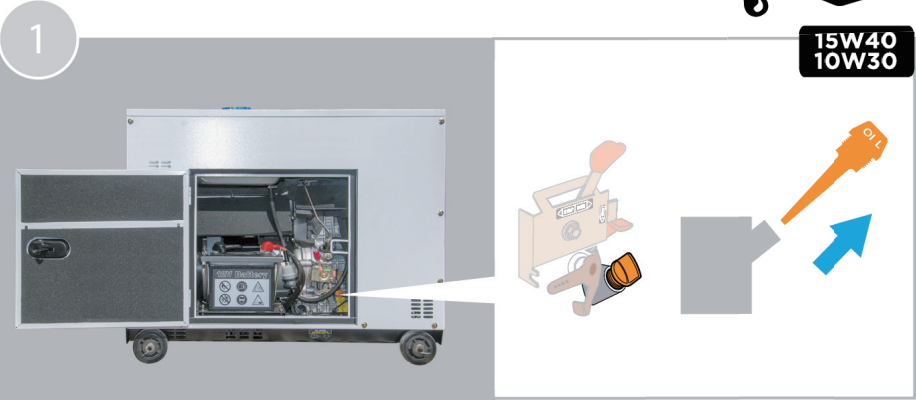

CONNECTING THE BATTERY CABLE

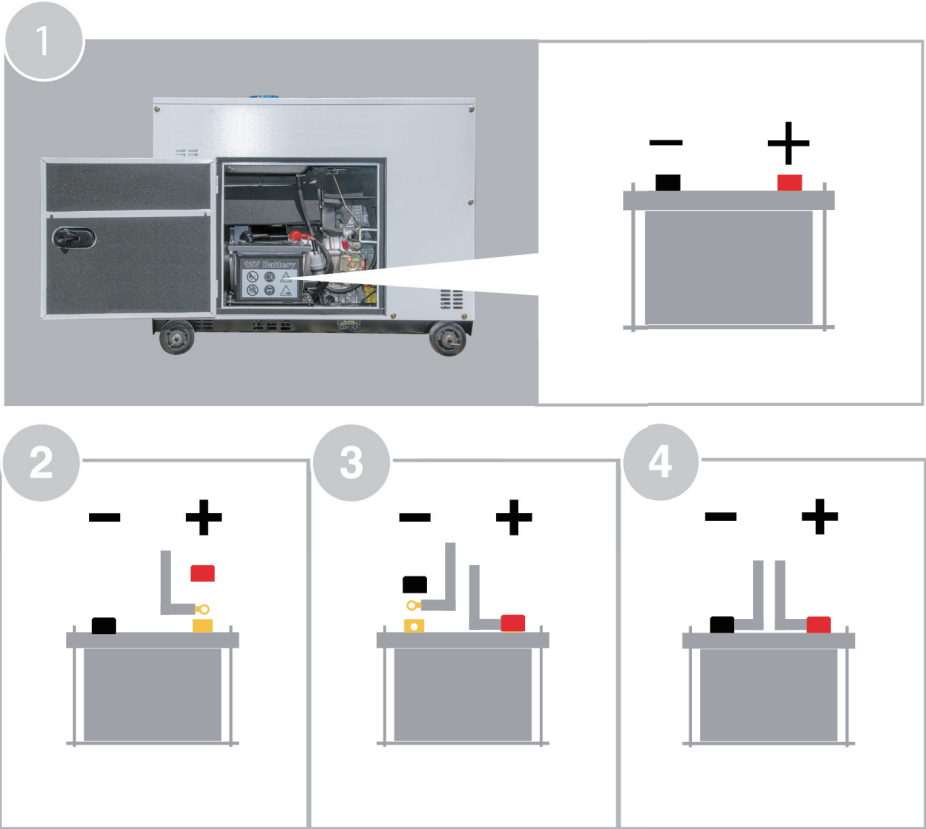

FILLING THE FUEL TANK

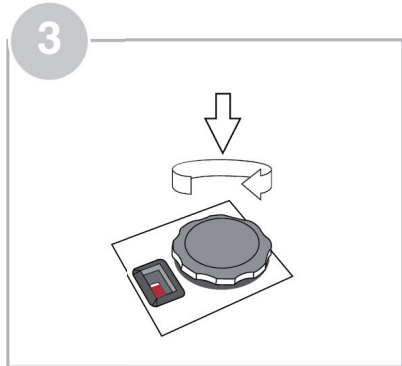
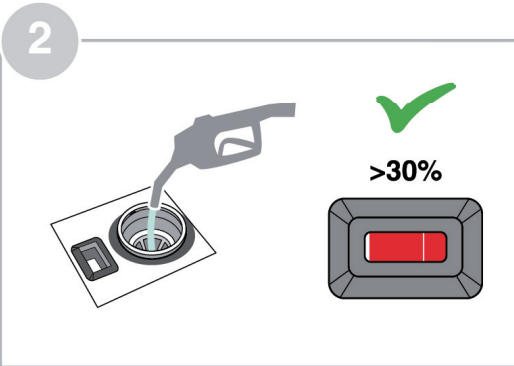
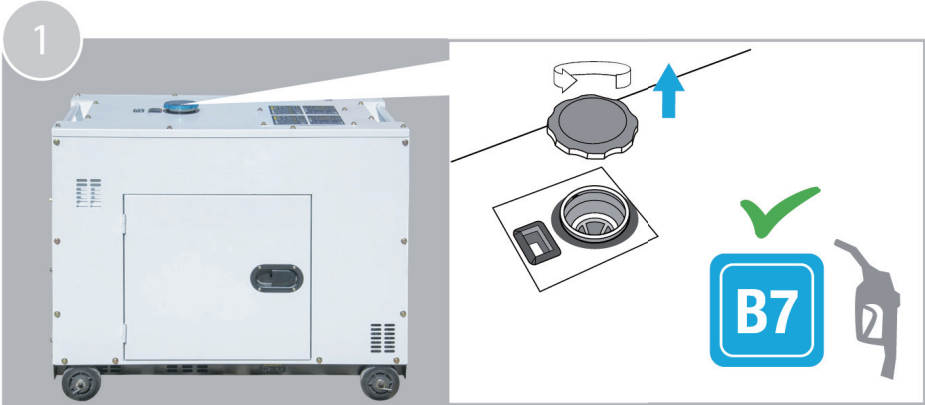

REMOVE AIR FROM FUEL PIPE

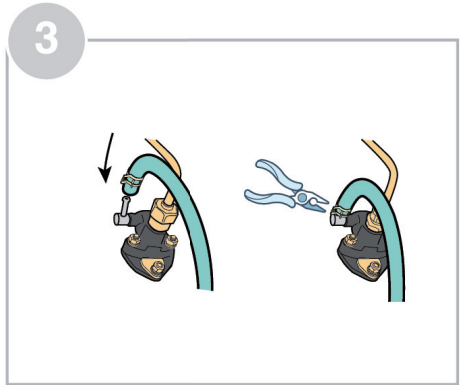
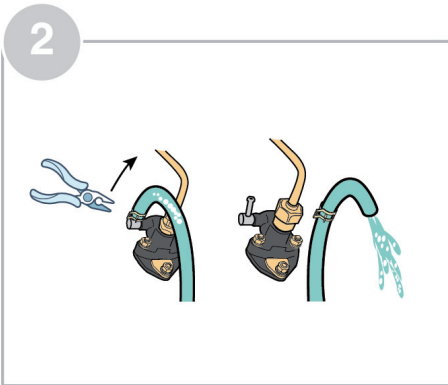
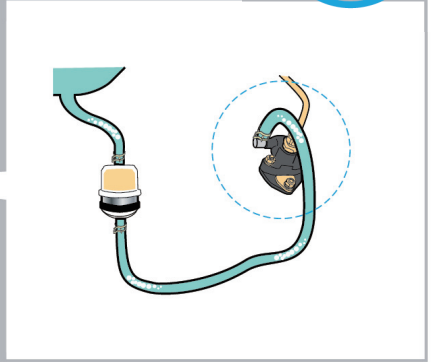

OPERATION - START



Check the oil level whenever the appliance is to be put into operation.
Add engine oil if necessary.



To ensure quality, each piece of equipment undergoes a test run and is filled with motor oil.
Although the oil is drained before transport, some residue may remain on the dipstick.
Please check the oil level carefully and top up with motor oil as needed.

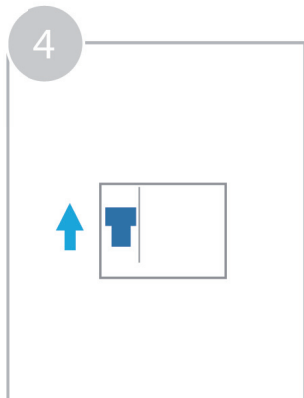
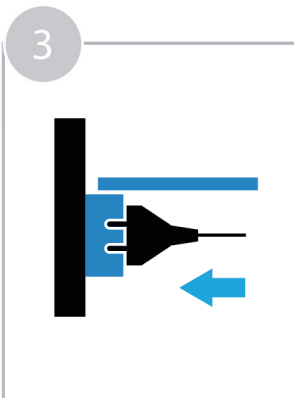
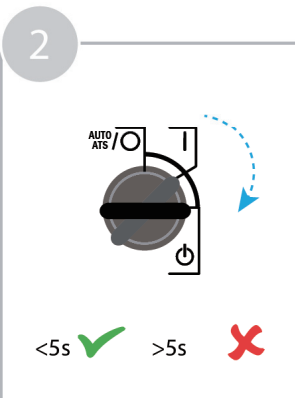
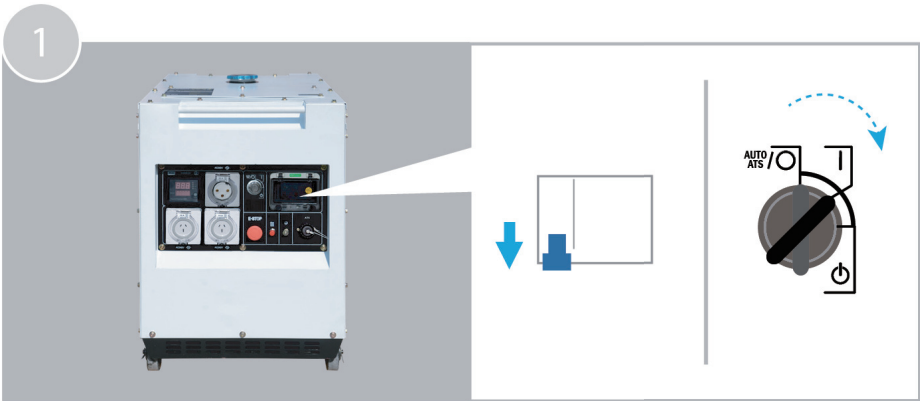

OPERATION - AUTO START



Check the oil level whenever the appliance is to be put into operation.
Add engine oil if necessary.



To ensure quality, each piece of equipment undergoes a test run and is filled with motor oil.
Although the oil is drained before transport, some residue may remain on the dipstick.
Please check the oil level carefully and top up with motor oil as needed.

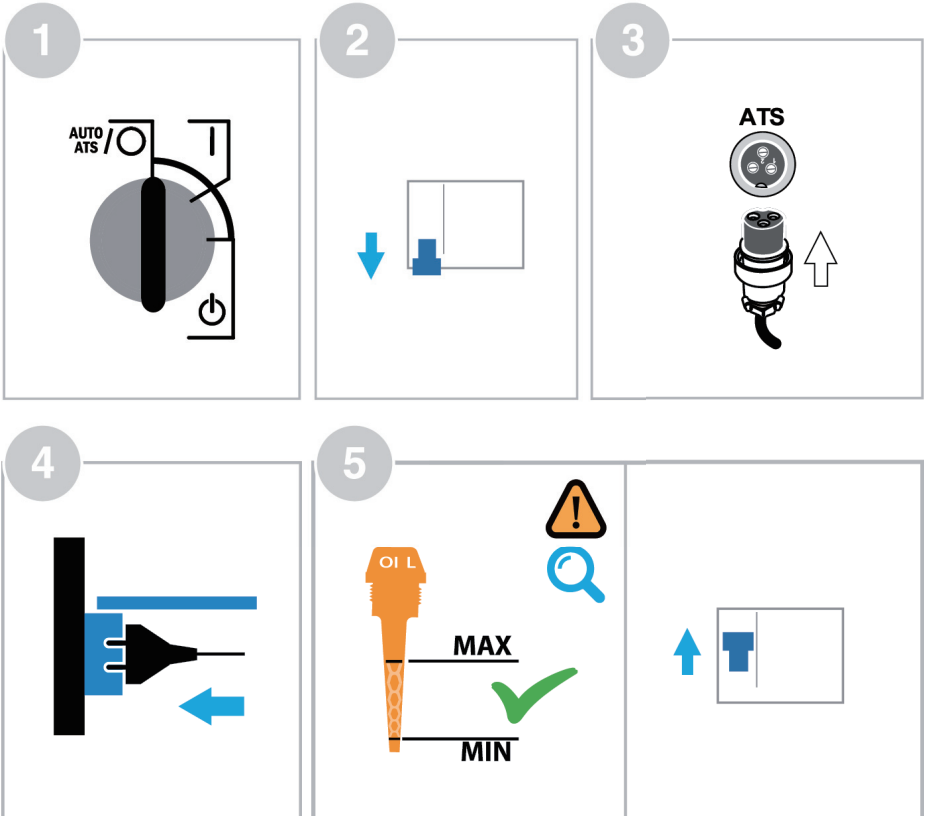

OPERATION STOP

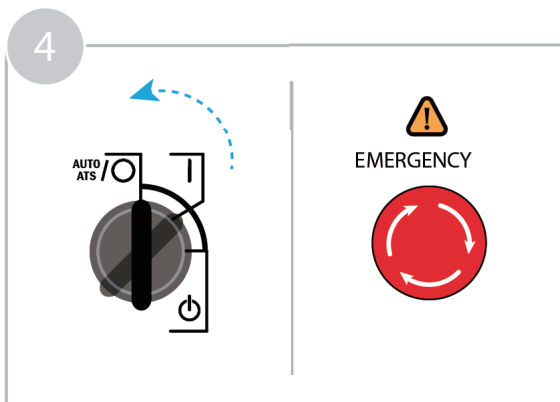
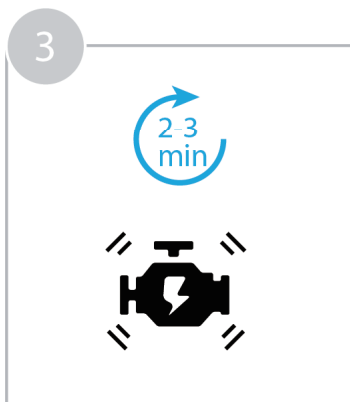
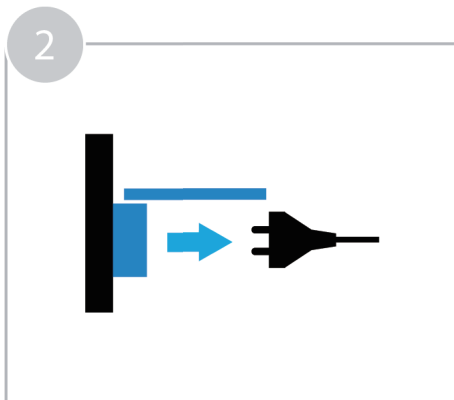
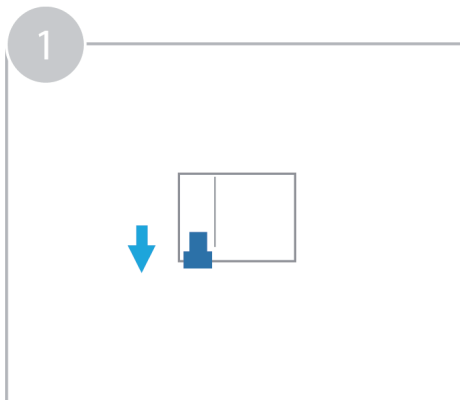

OIL CHANGE

first
20
hours

every
100
hours



15W40
10W30

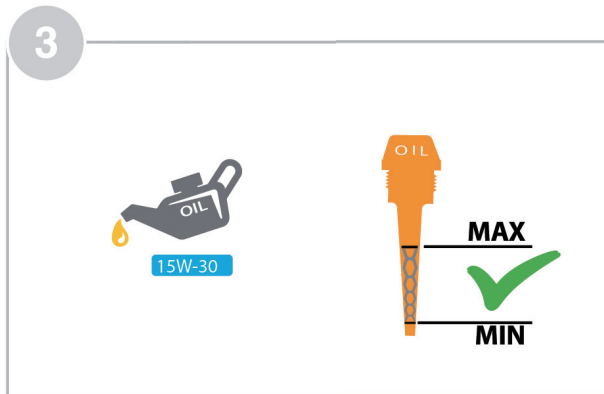
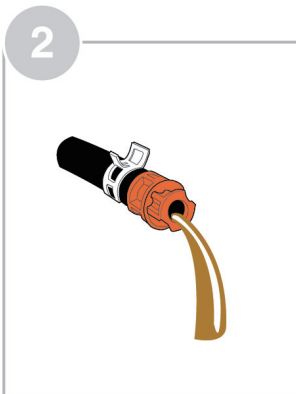
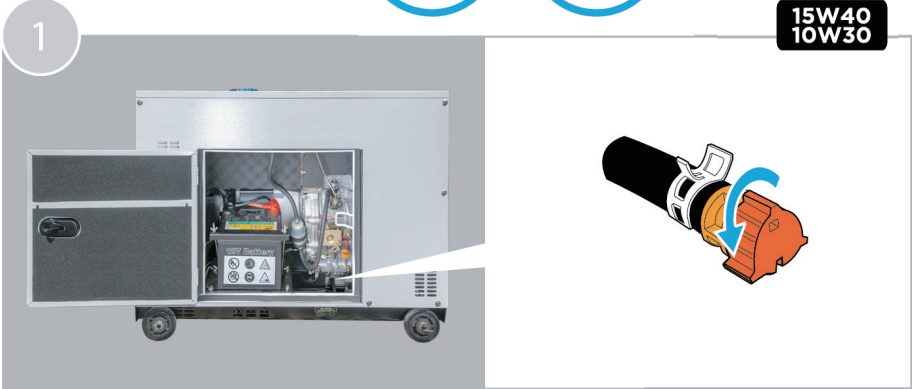

OIL FILTER

every
100
hours

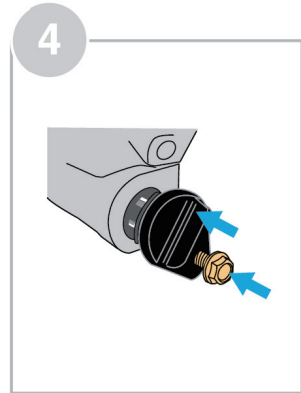
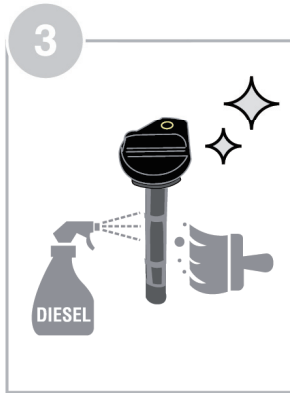
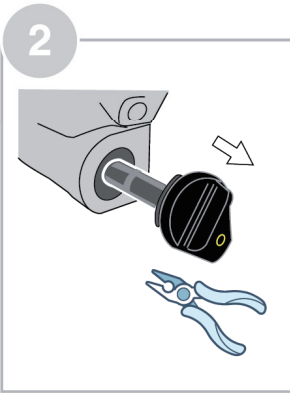
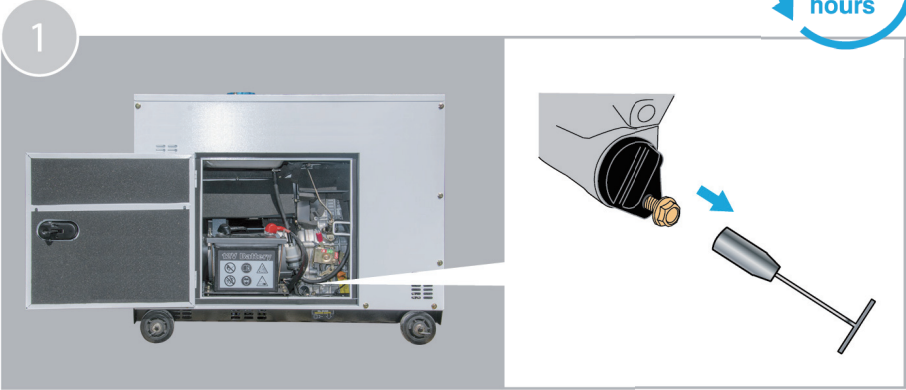

AIR FILTER

every
100
hours

1

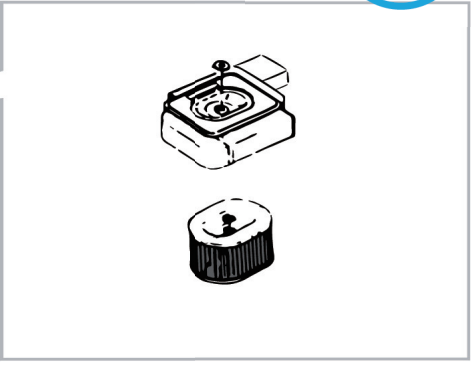
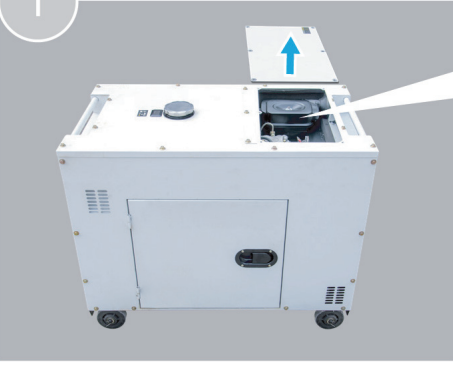

2

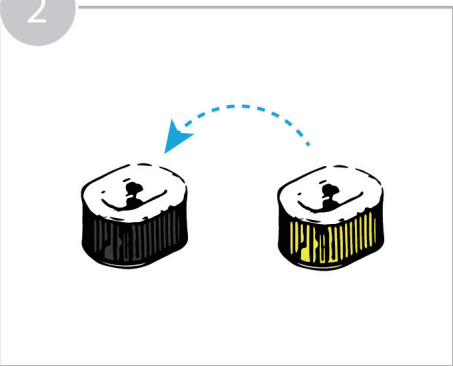

3



FUEL FILTER

every
100
hours

1



2

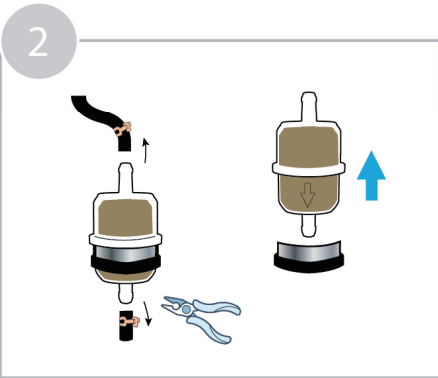

3

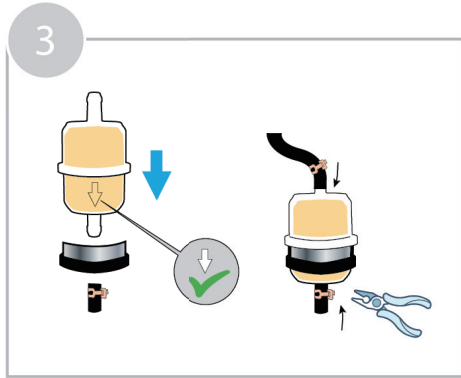









TECHNICAL DATA





MODEL		G10000DS-ILE
Frequency	Hz	50
Rated Power	kw	8
Max. Power	kw	8.5 kw
Voltage	V	240
Current	A	35.4
Plugs	A	15A / 32A
Display		LED6
Fuel Tank Capacity	L	25
Running Time @ 75% Load	H	10
Sound Level @ 7m	dBA	72
DC Output	V/A	12 / 8.3
Battery	V/Ah	12 / 36
ENGINE		D680E
Engine Type		Diesel
Power	HP	14.4
Start		Electric
Displacement	CC	678
Oil Capacity	L	2.4
ALTERNATOR		AL8
Power	kw	8
Power Factor		1
Voltage Regulation		Brush / AVR
DIMENSIONS & WEIGHT		
Net Weight	kg	225
Gross Weight	kg	243
Machine Size	mm	1080x570x750
Package Dimensions	mm	1120x610x870

TROUBLESHOOTING

MOTOR NOT STARTING

	CAUSES		SOLUTIONS
	Fuel shortage		Fill with fuel
	Air in the circuit		Drain air from circuit
	The start lever is not in the on position		Put the lever in the on position
	Not enough oil		Fill with oil to the upper mark on the rod
	Injector dirt		Clean the injector
	Dead Battery		Charge or replace battery
	The injector does not supply fuel		Replace the injector

GENERATOR DOES NOT GIVE CURRENT

	CAUSES		SOLUTIONS
	The lever is in the off position		Put the lever in the on position
	Bad contact at plug		Adjust plug
AVR	Damaged voltage regulator (AVR)		Replace voltage regulator (AVR)

BE POWER[®]
EQUIPMENT